

1BH-2.2-2.5-N-X

Omnidirectional, High Gain, High Temperature, Wify(2.2-2.5GHz) Antenna.

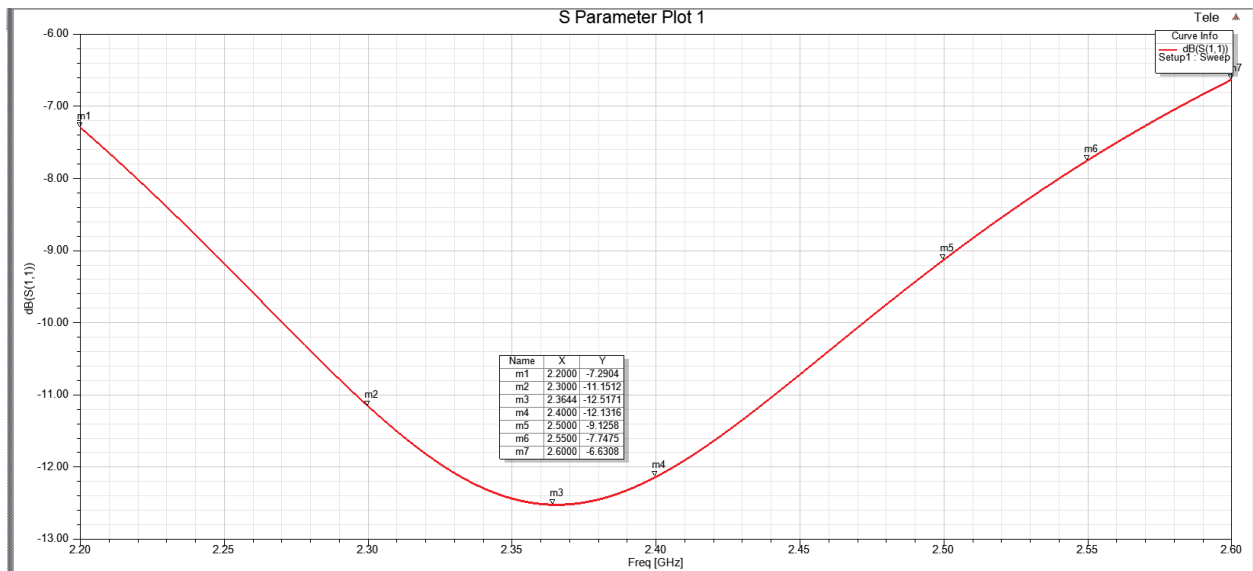

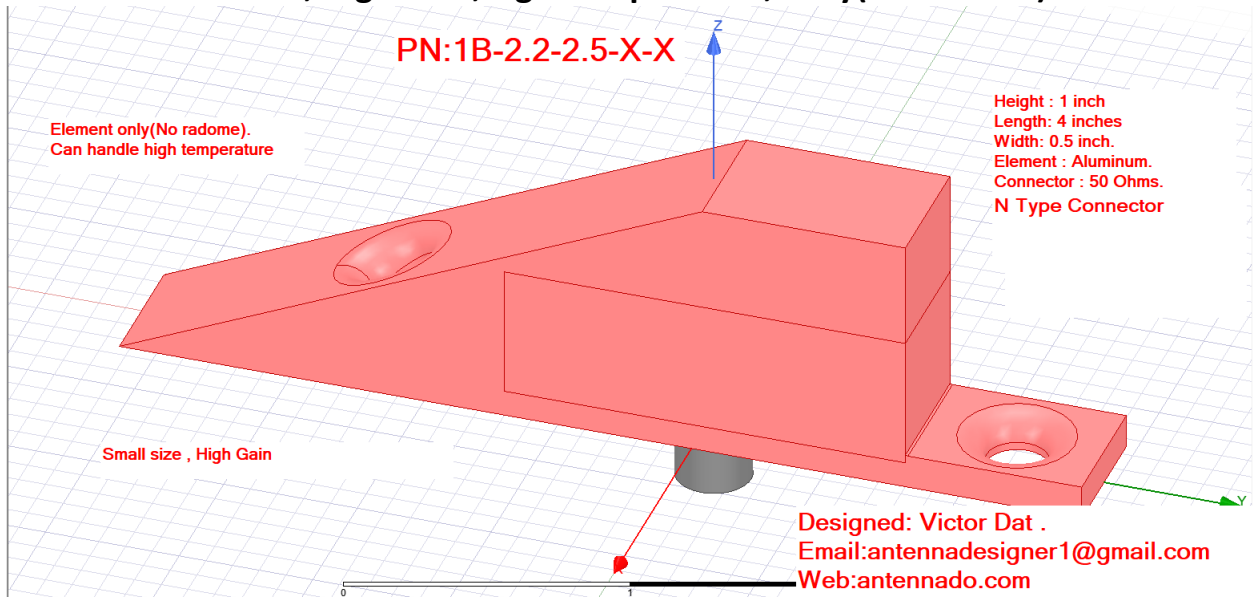
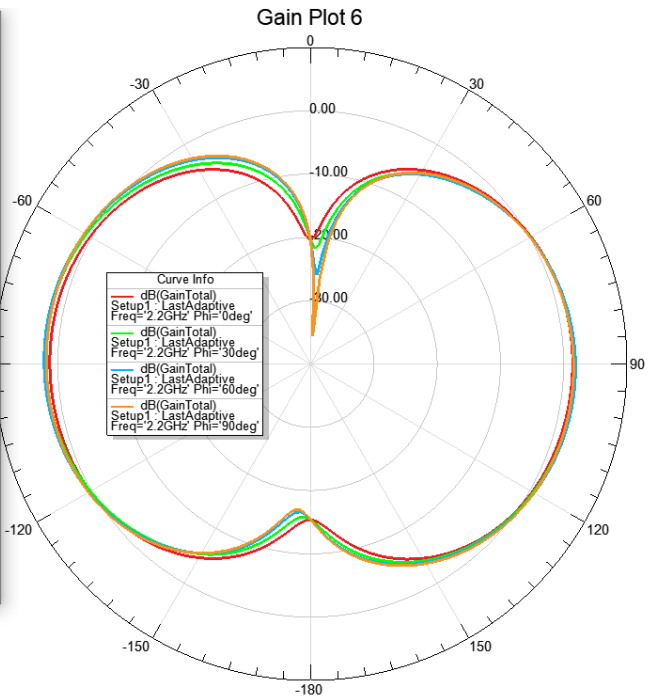
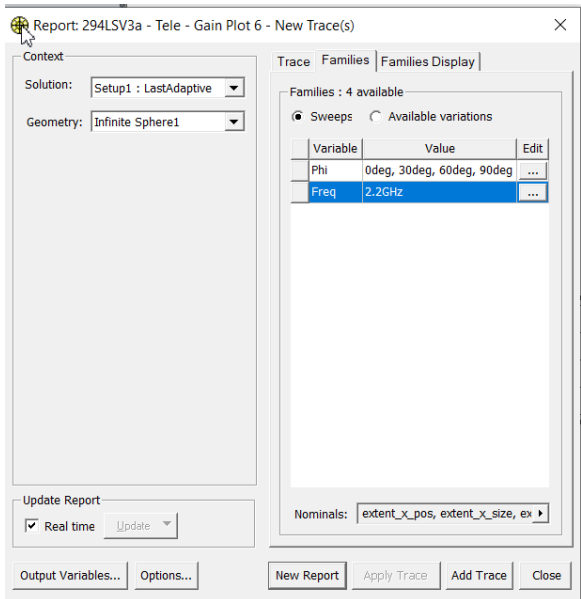
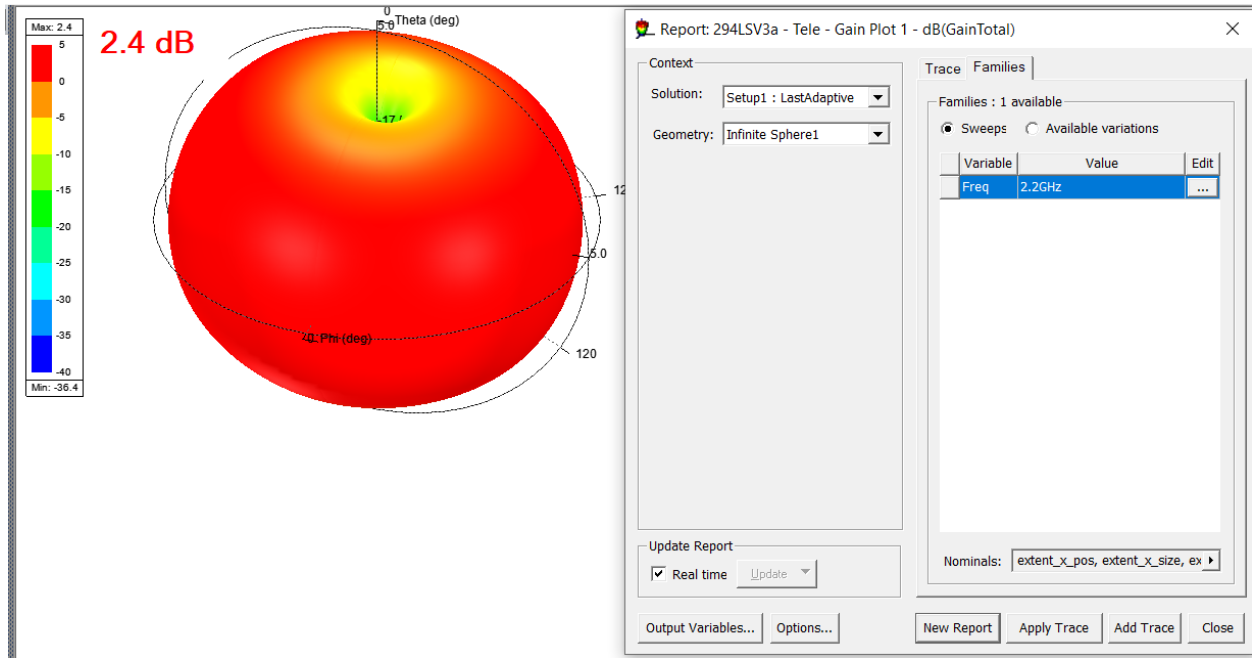

play
 s
 there1

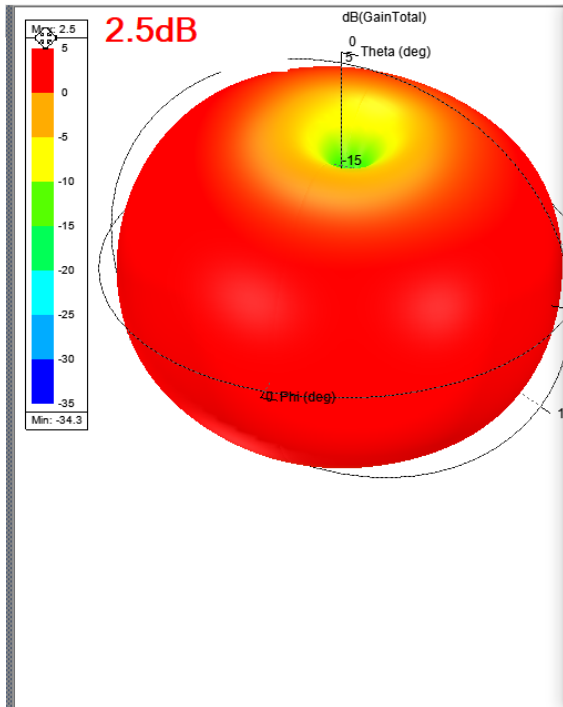

Report: 294LSV3a - Tele - Gain Plot 2 - dB(GainTotal)

Context

Solution: Setup1 : LastAdaptive

Geometry: Infinite Sphere1

Trace Families

Families : 1 available

Sweeps Available variations

Variable	Value	Edit
Freq	2.3GHz	...

Nominals: extent_x_pos, extent_x_size, ex ▶

Update Report

Real time

Report: 294LSV3a - Tele - Gain Plot 7 - New Trace(s)

Context

Solution: Setup1 : LastAdaptive

Geometry: Infinite Sphere1

Trace Families Families Display

Families : 4 available

Sweeps Available variations

Variable	Value	Edit
Phi	0deg, 30deg, 60deg, 90deg	...
Freq	2.3GHz	...

Nominals: extent_x_pos, extent_x_size, ex ▶

Update Report

Real time

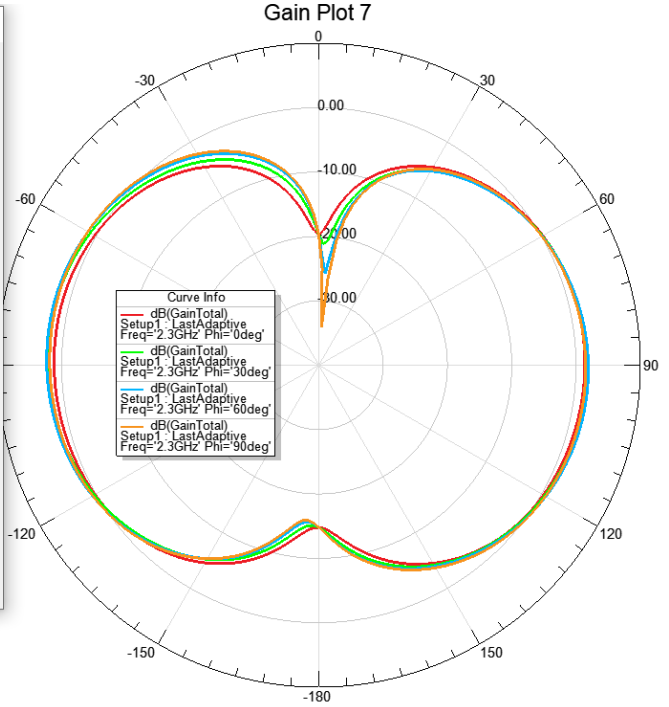

nTotal)

ilay

here1

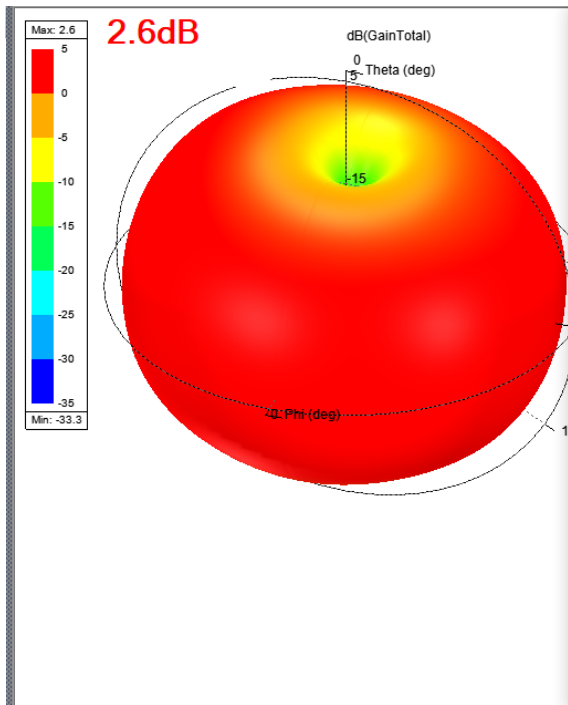

Report: 294LSV3a - Tele - Gain Plot 3 - dB(GainTotal)

Context
Solution: Setup1 : LastAdaptive
Geometry: Infinite Sphere1

Trace Families
Families: 1 available
Sweeps Available variations

Variable	Value	Edit
Freq	2.4GHz	...

Nominals: extent_x_pos, extent_x_size, ex

Update Report
 Real time Update

Output Variables... Options... New Report Apply Trace Add Trace Close

Report: 294LSV3a - Tele - Gain Plot 8 - New Trace(s)

Context
Solution: Setup1 : LastAdaptive
Geometry: Infinite Sphere1

Trace Families Families Display
Families: 4 available
Sweeps Available variations

Variable	Value	Edit
Phi	0deg, 30deg, 60deg, 90deg
Freq	2.4GHz	...

Nominals: extent_x_pos, extent_x_size, ex

Update Report
 Real time Update

Output Variables... Options... New Report Apply Trace Add Trace Close

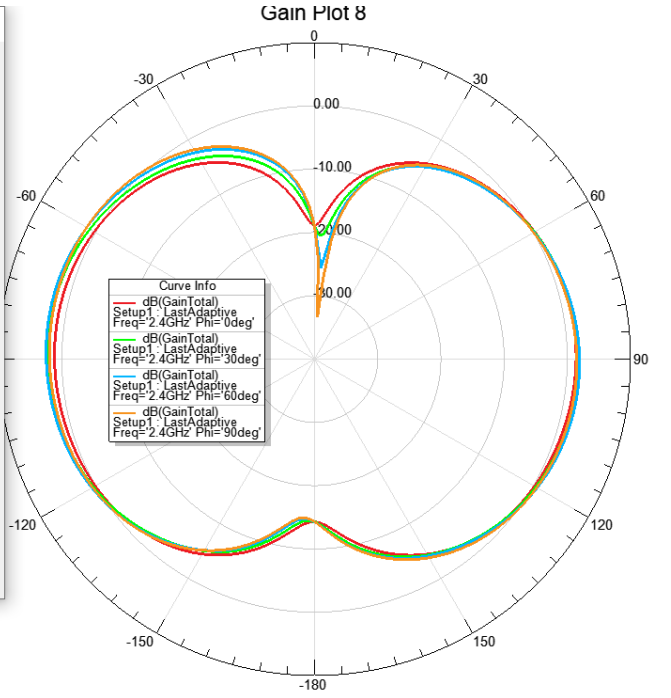

ainTotal)
t 8
ainTotal)
splay
vs

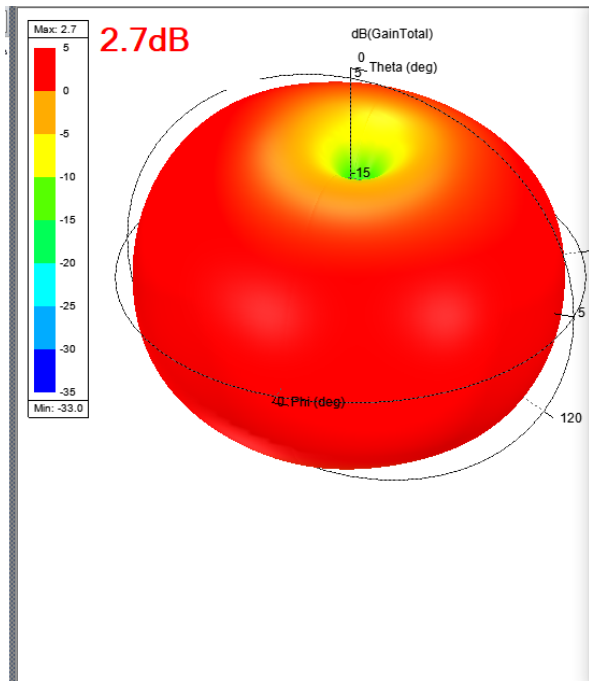

Report: 294LSV3a - Tele - Gain Plot 4 - dB(GainTotal)

Context

Solution: Setup1 : LastAdaptive

Geometry: Infinite Sphere1

Trace Families

Families : 1 available

Sweeps Available variations

Variable	Value	Edit
Freq	2.5GHz	...

Nominals: extent_x_pos, extent_x_size, ex ▶

Update Report

Real time

Report: 294LSV3a - Tele - Gain Plot 9 - New Trace(s)

Context

Solution: Setup1 : LastAdaptive

Geometry: Infinite Sphere1

Trace Families Families Display

Families : 4 available

Sweeps Available variations

Variable	Value	Edit
Phi	0deg, 30deg, 60deg, 90deg	...
Freq	2.5GHz	...

Nominals: extent_x_pos, extent_x_size, ex ▶

Update Report

Real time

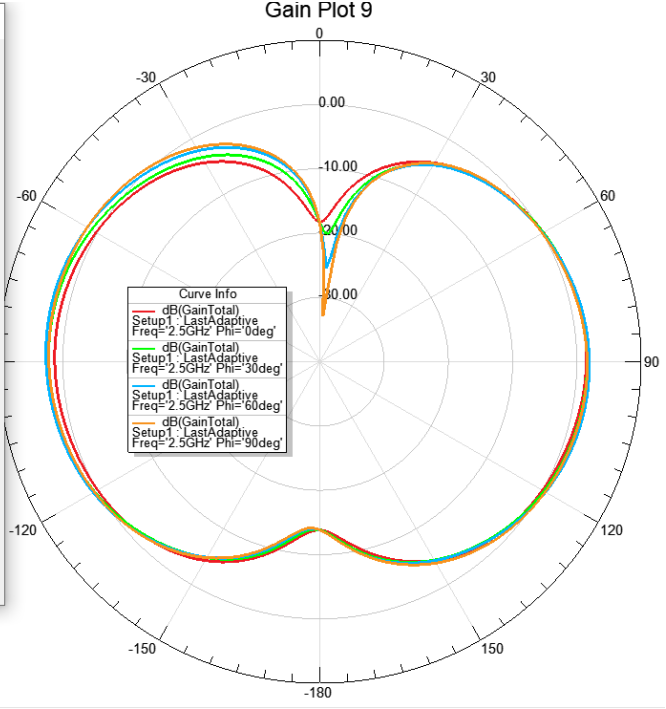

ainTotal)

8

ainTotal)

t 9

ainTotal)

solav